

use & care guide

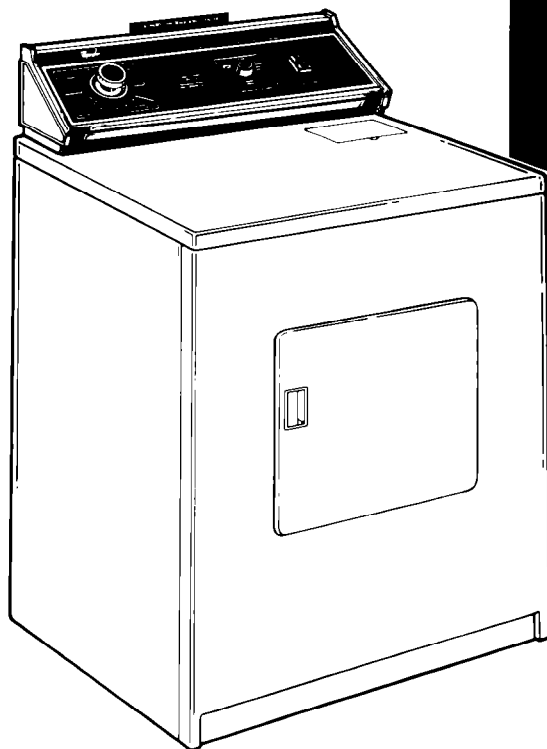

AUTOMATIC DRYER

**Electric Model
GLE7900XM**

1-93

ive Ovens, Trash Compactors, Room Air Conditioners, Dehumidifiers, Automatic Washers, Clothes Dryers, Freezers, Refrigerator-Freezer

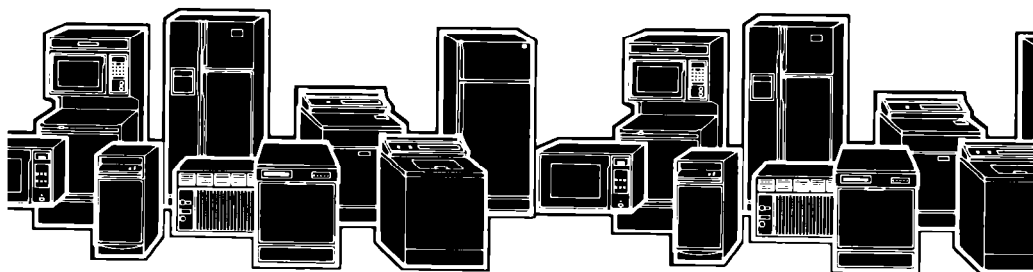

Parts and features

CYCLE CONTROL KNOB

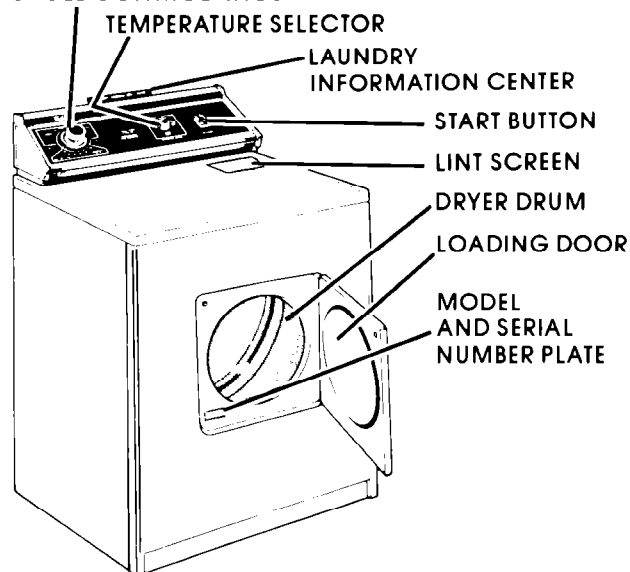

Remove the Consumer Buy Guide label before using your dryer. It will be easier to remove.

Wipe out the dryer drum with a damp cloth to remove dust from storing or shipping.

Copy your Model and Serial Numbers here

When you need service or call with a question, have this information ready:

- 1. Complete** Model and Serial Numbers (from the plate located as shown).
- 2.** Purchase date from sales slip.

Copy this information in these spaces. Keep this book, your warranty, sales slip and "Dryer Guide" in the Laundry Information Center on the back of the dryer console.

There is no warranty registration to return. Proof-of-purchase is all that is required for in-warranty service.

Complete Model Number

Complete Serial Number

Purchase Date

Service Company and Telephone Number

Contents

	Page		Page
PARTS AND FEATURES	2	LINT SCREEN	8
YOUR RESPONSIBILITIES	3	LINT REMOVAL	8
SAFETY FIRST	3	CARING FOR YOUR DRYER	9
SELECTING A CYCLE AND		Cleaning Dryer Interior	9
STARTING YOUR DRYER	4	Vacation Care	9
OPERATING INSTRUCTIONS ..	6	IF YOU NEED SERVICE OR	
Dryer Cycles and Settings ..	6	ASSISTANCE	10
Cool Down Times	6	1. Before Calling for	
DRYING TIPS	7	Assistance	10
FLUFF AIR	7	2. When You Return	
TUMBLE PRESS® Setting	7	to the U.S.	11
Mixed Loads	7	3. If You Need Assistance ...	11
Drying Times	7	4. If You Need Service	11

Your Responsibilities

Read this "Use and Care Guide" and your "Dryer Guide" carefully for important use and safety information.

You are personally responsible for making sure that your dryer...

- is installed by a qualified installer.
- is properly maintained.
- is installed in an area protected from the weather.
- is properly installed and leveled in a well ventilated room* on a floor that can support the weight.

- is located in an area where the temperature is above 45°F (7.2°C).
- is connected to the right kind of outlet, electric supply and grounding.*
- is properly connected to fuel and exhaust systems.*
- is used only for jobs normally expected of home clothes dryers.
- is not run where there may be explosive fumes.
- is not used by children or anyone unable to operate it properly.

*See the "Installation Instructions" for complete information.

Safety first

ALWAYS unplug the power supply cord or turn off electrical power before attempting to service the dryer.

NEVER use flammable fluids (dry-cleaning solvents, gasoline, kerosene) in or near your dryer.

ALWAYS hand launder or air dry fabrics treated with flammable fluids before putting them into your dryer.

NEVER dry items containing wax or paint in the dryer. The fumes can create a FIRE HAZARD.

FIRE HAZARD and DAMAGE to some materials can result from:

- drying heat-sensitive materials with heat (see page 4).
- operating the dryer with the lint screen loose, damaged or missing.
- allowing lint to build up inside the dryer (see page 8).

NEVER allow children to operate, play with, or crawl inside the dryer.

NEVER operate the dryer if...

- it is not working right.
- it is damaged.
- parts are missing.
- all panels are not in place.

DO NOT let dust, lint, paper, rags, chemicals, etc., pile up around or under the dryer. **DO NOT** install against drapes or curtains.

• FOR YOUR SAFETY •

DO NOT STORE OR USE GASOLINE OR OTHER FLAMMABLE VAPORS AND LIQUIDS IN THE VICINITY OF THIS OR ANY OTHER APPLIANCE.

Selecting a cycle and starting your dryer

Before starting your dryer, be sure laundry is sorted and loaded properly (see your "Dryer Guide").
Be sure the door is tightly closed.

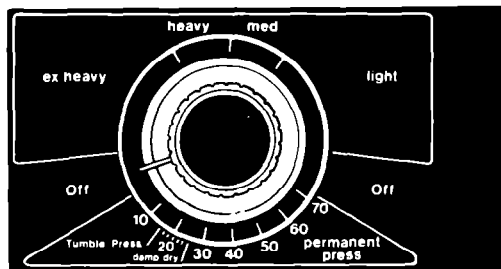

TYPE OF LOAD	SUGGESTED CYCLE	SUGGESTED TEMPERATURE
COTTONS – LINENS		
EXTRA HEAVY – Bedspreads, mattress pads, quilts	EX HEAVY	
HEAVYWEIGHT FABRICS – Towels, jeans, corduroys, work clothes	HEAVY	PERM'T PRESS HEAVY HIGH
MEDIUMWEIGHT COTTONS – Sheets, pillowcases, cotton underwear, diapers	MEDIUM	
LIGHTWEIGHT COTTONS – Batistes, organdies, lingerie	LIGHT	
PERMANENT PRESS, SYNTHETICS AND BLENDS		
HEAVYWEIGHT FABRICS – Work clothes, jackets, raincoats	40-50 MINS.	PERM'T PRESS HEAVY HIGH
MEDIUMWEIGHT FABRICS – Shirts, play clothes, sheets, slacks	30-40 MINS.	
LIGHTWEIGHT FABRICS – Lingerie, blouses, dresses	20-30 MINS.	
KNITS		
HEAVYWEIGHT – Cottons, rayons, blends, T-shirts, slacks, shirts	40-50 MINS.	PERM'T PRESS HEAVY HIGH
LIGHTWEIGHT – Synthetics (polyester, acrylic, etc.) and blends, lingerie, blouses, dresses	30-40 MINS.	KNITS GENTLE LOW
LIGHTWEIGHT AND DELICATE FABRICS		
Sheer Curtains (2 or 3 panels)	20-30 MINS.	KNITS GENTLE LOW
Gauze, lace, etc.	15-20 MINS.	
RUBBER, PLASTIC, HEAT-SENSITIVE FABRICS		
FOAM RUBBER – Pillows, bras, stuffed toys	20-30 MINS.	FLUFF AIR
PLASTIC – Shower curtains, tablecloths	20-30 MINS.	
RUBBER-BACKED RUGS	40-50 MINS.	
OLEFIN, POLYPROPYLENE, SHEER NYLON	15-20 MINS.	



WARNING: Drying these and other heat-sensitive materials with heat can damage them or be a FIRE HAZARD.

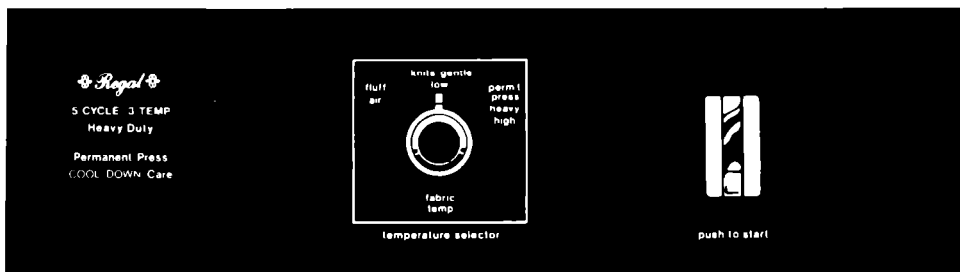

1. CYCLE

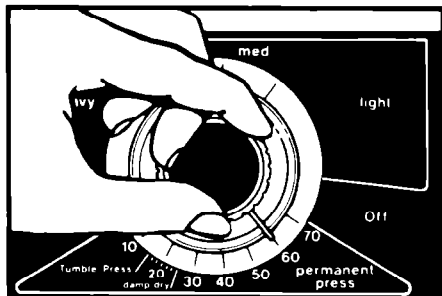

Turn the Control Knob either way to point to the cycle and setting you want. See page 6 for information on the cycles.

2. SET TEMPERATURE SELECTOR

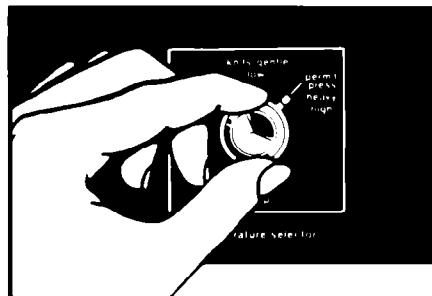

Turn the Temperature Selector to the needed drying temperature.

3. START

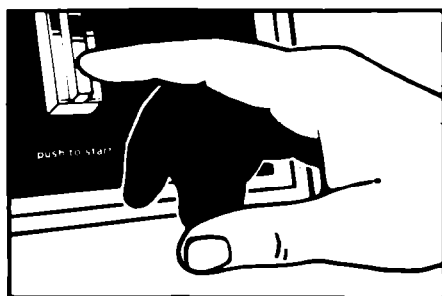

The dryer will start tumbling when you push the START Button.

To stop and restart the dryer

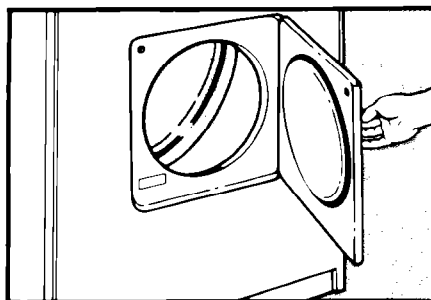

To stop the dryer, open the door (or turn the Control Knob to OFF).

To restart the dryer, close the door, select cycle, if necessary, and push START.

Changing a setting

The setting can be changed at any time by turning the Control Knob to a new setting.

The Cycle Control Knob should point to OFF when the dryer is not in use.

Operating instructions

Dryer cycles and settings

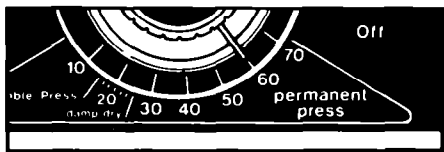

The PERMANENT PRESS Cycle helps provide the special care that permanent press and synthetic fabrics need...a period of heated drying followed by a 10 minute cool down. The chart on page 4 suggests time and temperature settings for different kinds of loads.

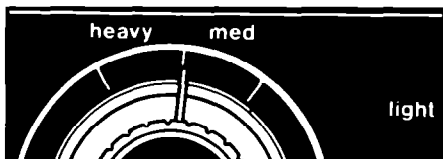

The **EX HEAVY, HEAVY, MEDIUM** and **LIGHT** cycles describe the loads they are designed to dry. The chart on page 4 tells what is meant by EX HEAVY, HEAVY, MEDIUM and LIGHT loads.

At each setting, the dryer will run about long enough to dry the load described by the setting. Example:

The HEAVY Cycle is designed to be long enough to dry a load of heavy fabrics (towels, jeans, corduroys, etc.) when the Temperature Selector is set on PERM'T PRESS/HEAVY HIGH.

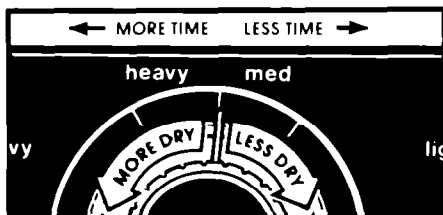

If the load is not as dry as you want, set the dial more to the **left** the next time you dry that kind of load.

If the load is dryer than you want, set the dial more to the **right** the next time you dry that kind of load.

Cool down times

In all cycles, the heat shuts off before the dryer stops tumbling. This cool down time helps:

- keep wrinkles from setting in.
- make handling the hot load items easier.

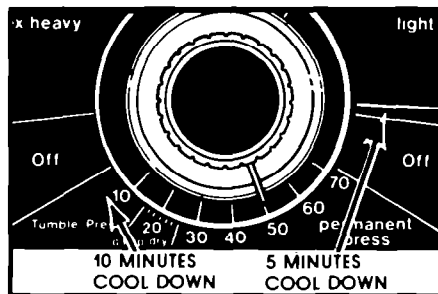

The PERMANENT PRESS Cycle has 10 minutes of cool down time at the end of the cycle.

All other cycles have 5 minutes of cool down time.

Overdrying can cause shrinkage, static cling and damage to some fabrics.

To help reduce wrinkling, take the load from the dryer as soon as tumbling stops. This is very important for permanent press, knits and synthetic fabrics.

Drying tips

FLUFF AIR

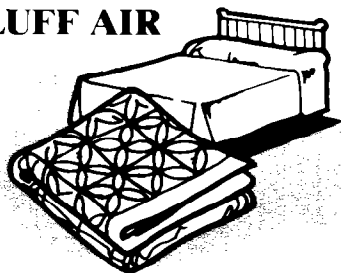

The dryer does not heat when the Temperature Selector is set on FLUFF AIR. This setting can be used to fluff bedding, pillows and clothing or to dust drapes.

It can also be used to damp-dry heat sensitive items...such as plastic shower curtains, rubber-backed rugs, plastic tablecloths, foam rubber pillows, stuffed toys, sneakers, etc.



WARNING: Drying plastic or rubber items with heat may damage the items or be a FIRE HAZARD.

1. Set the Temperature Selector to FLUFF AIR.
2. Set the Control Knob to the PERMANENT PRESS Cycle and select the number of minutes you want.
3. Push the START Button.

TUMBLE PRESS® Setting

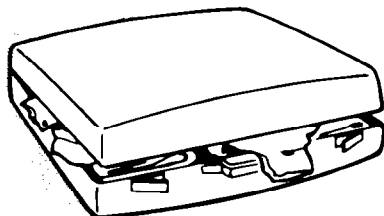

The TUMBLE PRESS setting removes wrinkles from dry clothing such as items that may have been packed in a suitcase, closet, or items not removed from the dryer.

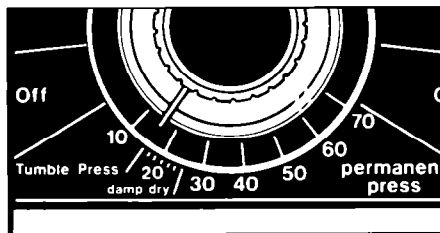

Set Temperature Selector to PERM'T PRESS / HEAVY HIGH.

2. Set Control Knob to TUMBLE PRESS.
3. Push START Button.

The load will tumble in heated air for 5 minutes. The heat shuts off and the dryer continues to tumble the load for 10 more minutes.

For best results, TUMBLE PRESS only a few items at a time. Put them on hangers or fold them as soon as the dryer stops.

Mixed loads

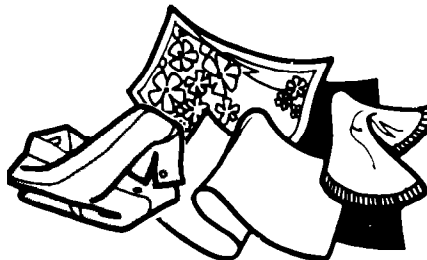

When drying a load with different kinds and weights of fabrics, use the cycle suggested for the lightest fabrics. When the dryer stops, remove dry items and reset the control.

Drying times

Drying times will vary depending on:

- amount of moisture in the clothes.
- type and weight of the fabric.
- size of the load.
- room temperature around the dryer.
- temperature of the wash rinse water.
- amount of lint in the lint screen.
- dryer temperature selection.

See page 6 in your "Dryer Guide" for more information.

Lint screen

Clean the lint screen before each load. A screen blocked by lint can increase drying time and may be a FIRE HAZARD.

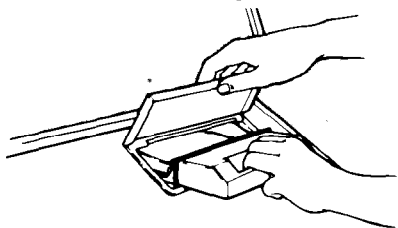

Open the lid and pull the lint screen straight out.

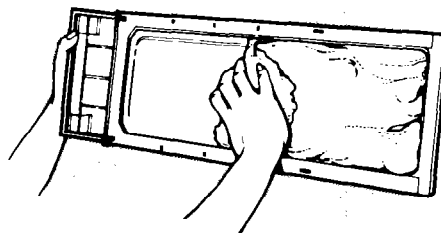

ROLL the lint off the screen with your fingers.
DO NOT rinse or wash the screen.



Lint removal

Lint can gather inside the dryer and create a fire hazard. **This lint should be removed every 2 to 3 years, or more often, depending on dryer usage.**

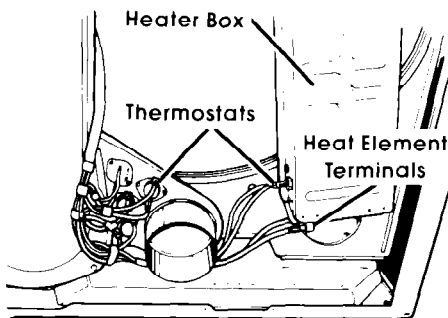

ELECTRIC DRYERS

Cleaning should be done only by a qualified person.



WARNING:

- **Avoid electrical shock hazard – unplug power supply cord or turn off electrical power.**
- **Avoid injury or damage – do not put hands inside cabinet.**
- **Make sure dryer is cool.**

1. Remove back panel (electric) or lower access panel (gas).
2. Avoid damaging wires, thermostats, funnel or igniter.
3. Remove lint from shaded area – see art – with a soft brush or vacuum cleaner.
4. Replace panel; reconnect and re-level dryer.

Caring for your dryer



Remove loose and sharp objects from pockets and cuffs before drying – pins, buckles, etc. **Close metal zippers.**



Wipe off all spills with a damp, soft cloth. Spills allowed to remain may dull or damage the finish.

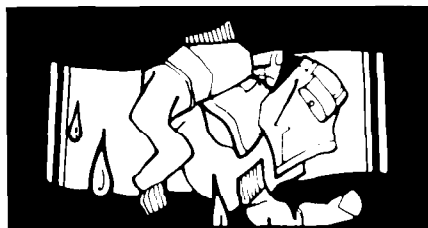

Never leave wet or damp laundry in your dryer.

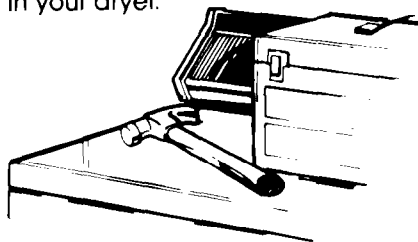

Sharp or heavy objects should never be put on or in the dryer. Check pockets for bolts, nuts, etc.

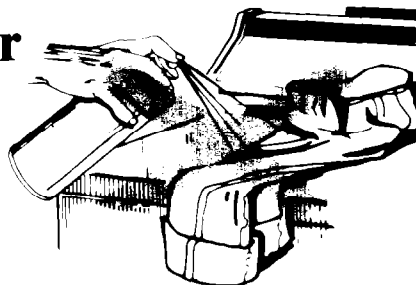

Some pretreatment products can damage dials, consoles and finish. Do not use these products on or near your dryer.

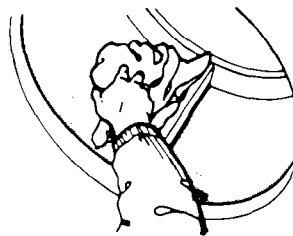

Cleaning dryer interior



Before cleaning interior, unplug power supply cord or turn off electrical power to avoid electrical shock hazard.

Garments which contain unstable dyes, such as denim blue jeans or brightly colored cotton items, may discolor the dryer interior. If the interior is discolored, clean with one of the following methods to avoid staining later load items.

Powdered laundry detergent and very warm water

Make a paste with detergent and very warm water. Apply paste to a soft cloth and scrub area until all excess dye is removed. Wipe thoroughly with a damp cloth. Tumble a load of rags. –OR–

Liquid spray household cleaner

Spray on stained area. Rub with a cloth until all excess dye is removed. Tumble a load of rags.

Vacation care

- Unplug power cord or turn off electrical power.
- Clean lint screen.

If you need service or assistance, we suggest you follow these four steps:



1. Before calling for assistance...

Performance problems often result from little things you can find and fix yourself without tools of any kind.

If your dryer does not run:

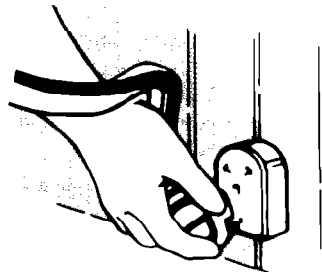

- Is the power supply cord plugged into a live circuit with the proper voltage?
- Is the door closed tightly?
- Did you push the START Button?

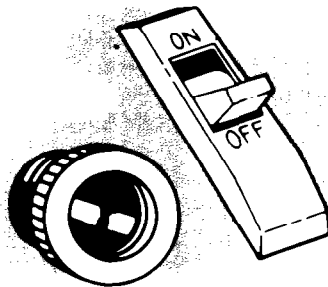

- Have you checked your home's main fuses or circuit breaker box?

If your dryer does not heat:

- The AIR setting is without heat.
- The last minutes of heat settings are without heat.
- An electric dryer uses a circuit breaker or 2 fuses. If one fuse is blown, the dryer may run, but not heat.

If drying time seems long:

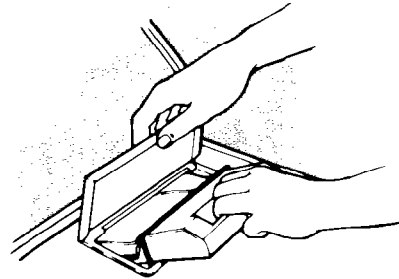

- Is the lint screen clean?
- See page 7 of this book and page 6 of your "Dryer Guide."

2. When you return to the United States...

Migratory Policy

We realize that you're purchasing a Whirlpool appliance for what may be a temporary stay in a particular area. If you are transferred to the United States and find that your Whirlpool appliance requires service within the warranty period, simply contact a Whirlpool authorized dealer or service agent. All he'll require is proof of the purchase date of the appliance. Service will be supplied at no charge.

NOTE:

The parts to convert this machine to 120 volt, 60 Hz operation are included in the console of the machine. These parts must be installed by an authorized Whirlpool service agent.

3. If you need assistance*...

Call Whirlpool COOL-LINE® service assistance telephone number. Dial free from:

Continental U.S. . (800) 253-1301
Michigan (800) 632-2243
Alaska & Hawaii (800) 253-1121

and talk with one of our trained Consultants. The Consultant can instruct you in how to obtain satisfactory operation from your appliance or, if service is necessary, recommend a qualified service company in your area.

4. If you need service*...



Whirlpool has a nationwide network of franchised TECH-CARE® Service Companies. TECH-CARE service technicians are trained to fulfill the product warranty and provide after-warranty service, anywhere in the United States. To locate TECH-CARE service in your area, call our COOL-LINE service assistance telephone number (see Step 2) or look in your telephone directory Yellow Pages under:

APPLIANCES - HOUSEHOLD MAJOR - SERVICE & REPAIR	OR	ELECTRICAL APPLIANCES - MAJOR - REPAIRING & PARTS
WHIRLPOOL APPLIANCES FRANCHISED TECH-CARE SERVICE		WHIRLPOOL APPLIANCES FRANCHISED TECH-CARE SERVICE
SERVICE COMPANIES		
XYZ SERVICE CO. 123 Maple 999-9999		XYZ SERVICE CO. 123 Maple 999-9999
OR		
WASHING MACHINES, DRYERS & IRONERS - SERVICING		
WHIRLPOOL APPLIANCES FRANCHISED TECH-CARE SERVICE		
SERVICE COMPANIES		
XYZ SERVICE CO. 123 Maple 999-9999		



FSP is a registered trademark of Whirlpool Corporation for quality parts. Look for this symbol of quality whenever you need a replacement part for your Whirlpool appliance. FSP replacement parts will fit right and work right, because they are made to the same exacting specifications used to build every new Whirlpool appliance.

IF YOU NEED SERVICE OR ASSISTANCE



Making your world a little easier.

Part No. 696756
©1985 Whirlpool Corporation

Printed in U.S.A.

matic Washers, Clothes Dryers, Freezers, Refrigerator-Freezers, Ice Makers, Dishwashers, Built-In Ovens and Surface Units, Ranges, Mi

